



**Technical and Test Institute
for Construction Prague**
Prosecká 811/76a
190 00 Prague
Czech Republic
eota@tzus.cz



Member of



www.eota.eu

European Technical Assessment

**ETA 20/0106
of 30/01/2020**

(English language translation, the original version in Czech language)

Technical Assessment Body issuing the ETA:

Technical and Test Institute for Construction Prague

Trade name of the construction product

Friulsider Injection System KEM HR
KEM HR Blue
KEM HR Express
KEM HR Tropical

Product family to which the construction product belongs

Product area code: 33
Bonded anchor for use in concrete

Manufacturer

Friulsider S.p.A.
Via Trieste, 1
33048 san Giovanni al Natisone (Ud)
Italy

Manufacturing plant(s)

Friulsider S.p.A., Plant 1 Germany

This European Technical Assessment contains

23 pages including 20 Annexes which form an
integral part of this assessment.

This European Technical Assessment is issued in accordance with regulation (EU) No 305/2011, on the basis of

EAD 330499-01-0601

Translations of this European Technical Assessment in other languages shall fully correspond to the original issued document and should be identified as such.

Communication of this European Technical Assessment, including transmission by electronic means, shall be in full (excepted the confidential Annex(es) referred to above). However, partial reproduction may be made, with the written consent of the issuing Technical Assessment Body - Technical and Test Institute for Construction Prague. Any partial reproduction has to be identified as such.

1. Technical description of the product

The Friulsider Injection System KEM HR, KEM HR Blue, KEM HR Express and KEM HR Tropical for cracked and uncracked concrete is a bonded anchor consisting of a cartridge with injection mortar and a steel element. The steel elements consists of a commercial threaded rods with a hexagon nut and a washer or reinforcing bar.

The steel element is placed into a drilled hole filled with injection mortar and is anchored via the bond between metal part, injection mortar and concrete.

The illustration and the description of the product are given in Annex A.

2. Specification of the intended use in accordance with the applicable EAD

The performances given in Section 3 are only valid if the anchor is used in compliance with the specifications and conditions given in Annex B.

The provisions made in this European Technical Assessment are based on an assumed working life of the anchor of 50 years. The indications given on the working life cannot be interpreted as a guarantee given by the producer, but are to be regarded only as a means for choosing the products in relation to the expected economically reasonable working life of the works.

3. Performance of the product and references to the methods used for its assessment

3.1 Mechanical resistance and stability (BWR 1)

Essential characteristic	Performance
Characteristic resistance to tension and shear load for static and quasi-static loading	Annex C 1 to C 5
Displacements under short term and long term loading	Annex C 6 to C 7
Durability	Annex B 1
Characteristic resistance and displacements for seismic performance categories C1 and C2	Annex C 8 to C 10

3.2 Hygiene, health and environment (BWR 3)

No performance determined.

3.3 General aspects relating to fitness for use

Durability and serviceability are only ensured if the specifications of intended use according to Annex B1 are kept.

4. Assessment and verification of constancy of performance (AVCP) system applied with reference to its legal base

According to the Decision 96/582/EC of the European Commission¹ the system of assessment verification of constancy of performance (see Annex V to Regulation (EU) No 305/2011) given in the following table applies.

Product	Intended use	Level or class	System
Metal anchors for use in concrete	For fixing and/or supporting to concrete, structural elements (which contributes to the stability of the construction works) or heavy units	-	1

¹ Official Journal of the European Communities L 254 of 08.10.1996

5. Technical details necessary for the implementation of the AVCP system, as provided in the applicable EAD

The factory production control shall be in accordance with the control plan which is a part of the technical documentation of this European Technical Assessment. The control plan is laid down in the context of the factory production control system operated by the manufacturer and deposited at Technický a zkušební ústav stavební Praha, s.p.² The results of factory production control shall be recorded and evaluated in accordance with the provisions of the control plan.

Issued in Prague on 30.01.2020

By

Ing. Mária Schaan

Head of the Technical Assessment Body

² The control plan is a confidential part of the documentation of the European Technical Assessment, but not published together with the ETA and only handed over to the approved body involved in the procedure of AVCP.

Installation threaded rod

prepositioned installation or
push through installation (annular gap filled with mortar)

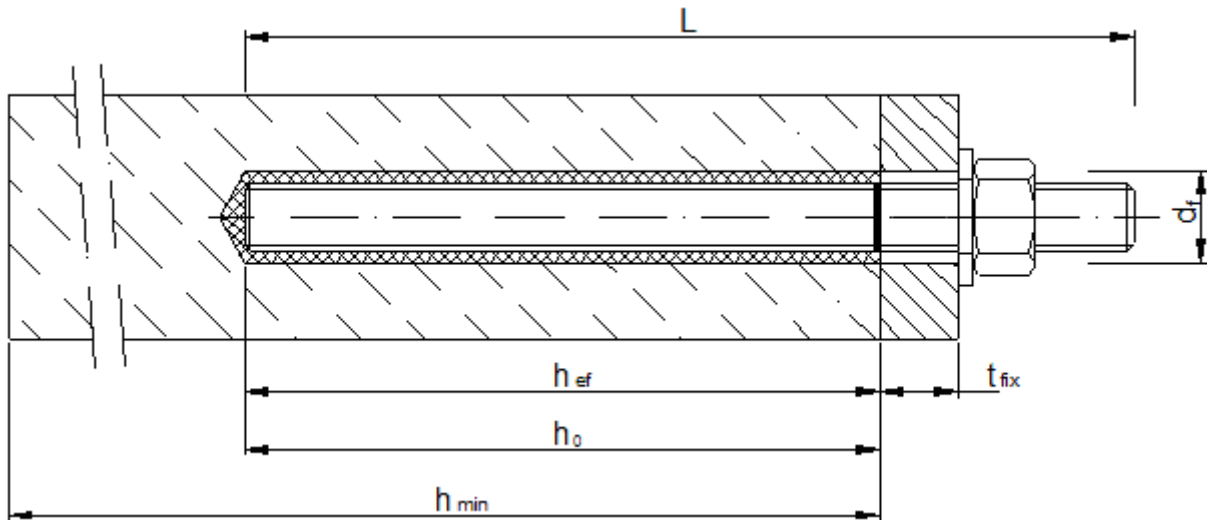

Installation reinforcing bar

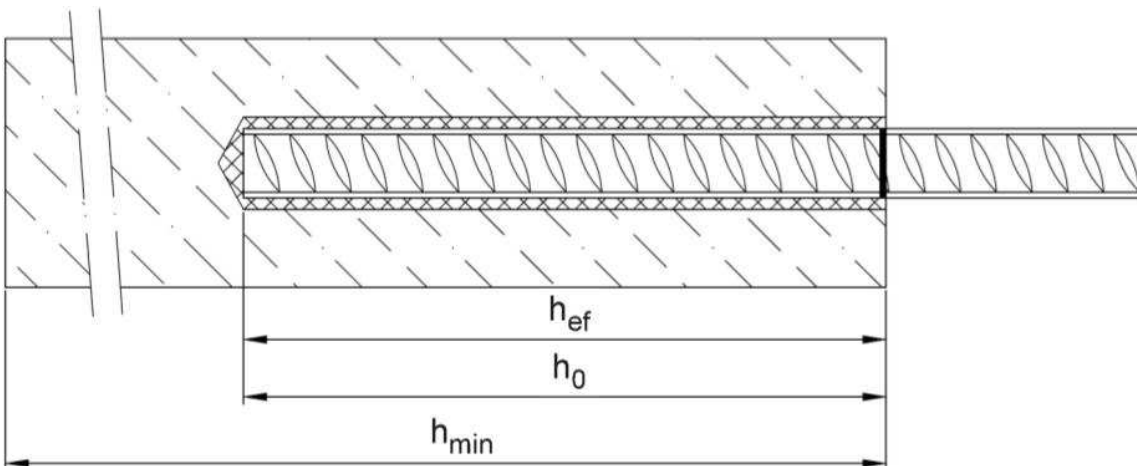

- d_f = diameter of clearance hole in the fixture
- t_{fix} = thickness of fixture
- h_{ef} = effective embedment depth
- h_0 = depth of drill hole
- h_{min} = minimum thickness of member

Friulside Injection System for concrete
KEM HR, KEM HR Blue, KEM HR Tropical, KEM HR Express

Product description
Installed conditions

Annex A 1

Cartridge:

150 ml, 280 ml, 300 ml up to 330 ml and 380 ml up to 420 ml cartridge (Type: coaxial)

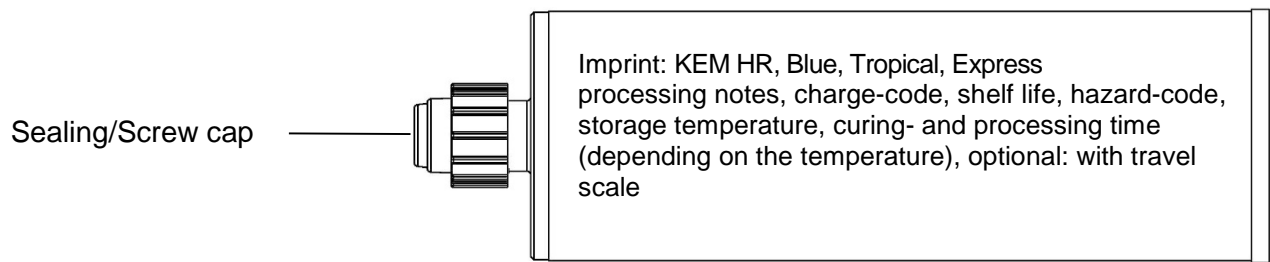

235 ml, 345 ml up to 360 ml and 825 ml cartridge (Type: “side-by-side”)

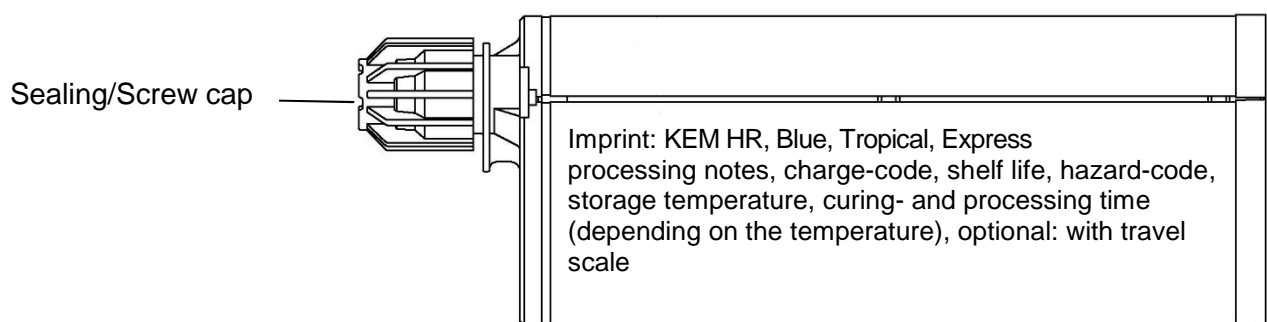

165 ml and 300 ml cartridge (Type: “foil tube”)

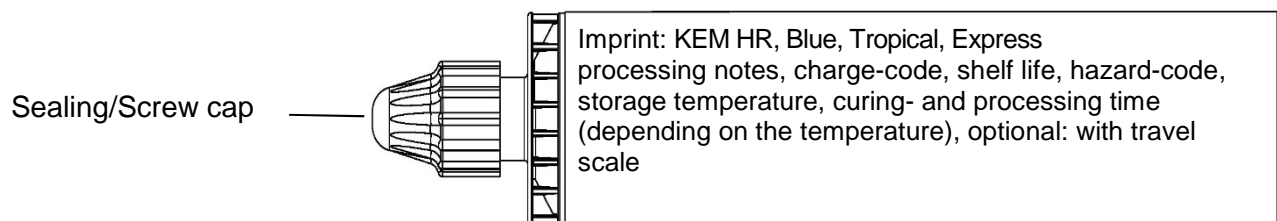

Static mixer

SM 14W



CM 8W



**Friulsider Injection System for concrete
KEM HR, KEM HR Blue, KEM HR Tropical, KEM HR Express**

Product description
Injection system

Annex A 2

Threaded rod M8, M10, M12, M16, M20, M24 with washer and hexagon nut

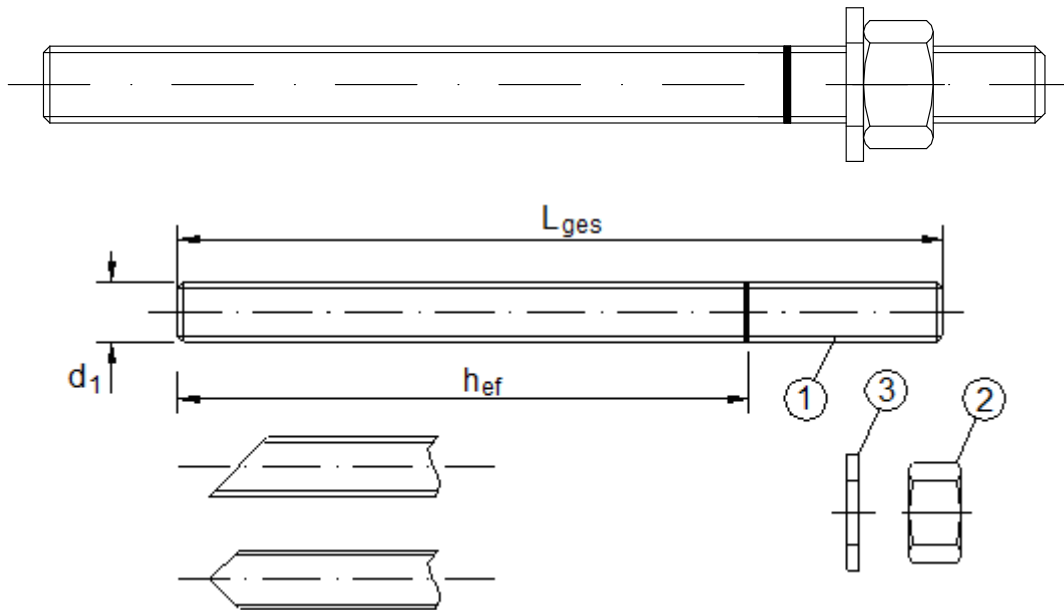

Commercial standard threaded rod with:

- Materials, dimensions and mechanical properties acc. Table A1
- Inspection certificate 3.1 acc. to EN 10204:2004
- Marking of embedment depth

Filling washer and mixer reduction nozzle for filling the annular gap between anchor rod and fixture

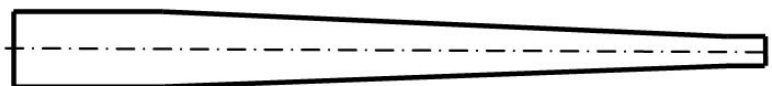

Friulsider Injection System for concrete
KEM HR, KEM HR Blue, KEM HR Tropical, KEM HR Express

Product description
 Threaded rod
 Filling washer

Annex A 3

Table A1: Materials

Part	Designation	Material				
Steel, zinc plated (Steel acc. to EN 10087:1998 or EN 10263:2001) <ul style="list-style-type: none"> - zinc plated $\geq 5 \mu\text{m}$ acc. to EN ISO 4042:1999 or - hot-dip galvanized $\geq 40 \mu\text{m}$ acc. to EN ISO 1461:2009 and EN ISO 10684:2004+AC:2009 or - sherardized $\geq 45 \mu\text{m}$ acc. to EN ISO 17668:2016 						
1	Anchor rod	Property class	Characteristic steel ultimate tensile strength	Characteristic steel yield strength	Elongation at fracture	
		acc. to EN ISO 898-1:2013	4.6	$f_{uk}=400 \text{ N/mm}^2$	$f_{yk}=240 \text{ N/mm}^2$	$A_5 > 8\%$
			4.8	$f_{uk}=400 \text{ N/mm}^2$	$f_{yk}=320 \text{ N/mm}^2$	$A_5 > 8\%$
			5.6	$f_{uk}=500 \text{ N/mm}^2$	$f_{yk}=300 \text{ N/mm}^2$	$A_5 > 8\%$
			5.8	$f_{uk}=500 \text{ N/mm}^2$	$f_{yk}=400 \text{ N/mm}^2$	$A_5 > 8\%$
8.8	$f_{uk}=800 \text{ N/mm}^2$	$f_{yk}=640 \text{ N/mm}^2$	$A_5 > 12\% ^2)$			
2	Hexagon nut	acc. to EN ISO 898-2:2012	4	for anchor rod class 4.6 or 4.8		
			5	for anchor rod class 5.6 or 5.8		
			8	for anchor rod class 8.8		
3a	Washer	Steel, zinc plated, hot-dip galvanized or sherardized (e.g.: EN ISO 887:2006, EN ISO 7089:2000, EN ISO 7093:2000 or EN ISO 7094:2000)				
3b	Filling washer	Steel, zinc plated, hot-dip galvanized or sherardized				
Stainless steel A2 (Material 1.4301 / 1.4311 / 1.4307 / 1.4567 or 1.4541, acc. to EN 10088-1:2014) Stainless steel A4 (Material 1.4401 / 1.4404 / 1.4571 / 1.4362 or 1.4578, acc. to EN 10088-1:2014) High corrosion resistance steel (Material 1.4529 or 1.4565, acc. to EN 10088-1: 2014)						
1	Anchor rod ¹⁾	Property class	Characteristic steel ultimate tensile strength	Characteristic steel yield strength	Elongation at fracture	
		acc. to EN ISO 3506-1:2009	50	$f_{uk}=500 \text{ N/mm}^2$	$f_{yk}=210 \text{ N/mm}^2$	$A_5 \geq 8\%$
			70	$f_{uk}=700 \text{ N/mm}^2$	$f_{yk}=450 \text{ N/mm}^2$	$A_5 > 12\% ^2)$
80	$f_{uk}=800 \text{ N/mm}^2$		$f_{yk}=600 \text{ N/mm}^2$	$A_5 > 12\% ^2)$		
2	Hexagon nut ¹⁾	acc. to EN ISO 3506-1:2009	50	for anchor rod class 50		
			70	for anchor rod class 70		
			80	for anchor rod class 80		
3a	Washer	A2: Material 1.4301, 1.4311 / 1.4307 / 1.4567 or 1.4541, EN 10088-1:2014 A4: Material 1.4401, 1.4404 / 1.4571 / 1.4362 or 1.4578, EN 10088-1:2014 HCR: Material 1.4529 or 1.4565, acc. to EN 10088-1: 2014 (e.g.: EN ISO 887:2006, EN ISO 7089:2000, EN ISO 7093:2000 or EN ISO 7094:2000)				
3b	Filling washer	Stainless steel A4, High corrosion resistance steel				
¹⁾ Property class 80 only for stainless steel A4 + high corrosion resistance steel HCR ²⁾ $A_5 > 8\%$ fracture elongation if <u>no</u> requirement for performance C2 exists						
Friulsider Injection System for concrete KEM HR, KEM HR Blue, KEM HR Tropical, KEM HR Express					Annex A 4	
Product description Materials threaded rod						

Reinforcing bar Ø 8, Ø 10, Ø 12, Ø 14, Ø 16, Ø 20, Ø 25

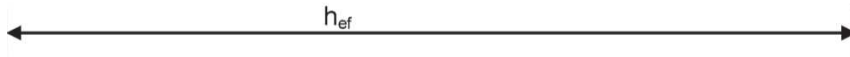

- Minimum value of related rib area $f_{R,min}$ according to EN 1992-1-1:2004+AC:2010
- Rib height of the bar shall be in the range $0,05d \leq h \leq 0,07d$
(d: nominal diameter of the bar; h: rib height of the bar)

Table A2: Materials

Part	Designation	Material
Reinforcing bars		
3	Rebar EN 1992-1-1:2004+AC:2010, Annex C	Bars are de-coiled rods class B or C f_{yk} and k according to NDP or NCL of EN 1992-1-1/NA $f_{uk} = f_{tk} = k \cdot f_{yk}$

Friulside Injection System for concrete
KEM HR, KEM HR Blue, KEM HR Tropical, KEM HR Express

Product description
 Reinforcing bar
 Materials reinforcing bar

Annex A 5

Specifications of intended use

Anchorage subject to:

- Static and quasi-static loads: Threaded rod M8 to M24, Rebar Ø 8 to Ø 25
- Seismic action for performance category C1: Threaded rod M8 to M16 (except hot-dip galvanised rods)
- Seismic action for performance category C2: Threaded rod M12 to M16 (except hot-dip galvanised rods)

Base materials:

- Reinforced or unreinforced normal weight concrete without fibres according to EN 206:2013+A1:2016.
- Strength classes C20/25 to C50/60 according to EN 206:2013+A1:2016.
- Uncracked concrete: Threaded rod M8 to M24, Rebar Ø 8 to Ø 25
- Cracked concrete: Threaded rod M8 to M16

Temperature range:

- T1: - 40 °C to +40 °C (max long term temperature +24 °C and max short term temperature +40 °C)
- T2: - 40 °C to +80 °C (max long term temperature +50 °C and max short term temperature +80 °C)

Use conditions (Environmental conditions):

- Structures subject to dry internal conditions (all materials)
- For all other conditions according to EN 1993-1-4:2006+A1:2015 corresponding to corrosion resistance class:
 - Stainless steel class A2 according to Annex A 4, Table A1: CRC II
 - Stainless steel class A4 according to Annex A 4, Table A1: CRC III
 - High corrosion resistance steel HCR according to Annex A 4, Table A1: CRC V

Design:

- Verifiable calculation notes and drawings are prepared taking account of the loads to be anchored. The position of the anchor is indicated on the design drawings (e. g. position of the anchor relative to reinforcement or to supports, etc.).
- Anchorages are designed under the responsibility of an engineer experienced in anchorages and concrete work.
- Anchorages under static or quasi-static actions are designed in accordance with EN 1992-4

Concrete condition:

- I1 – installation in dry or wet (water saturated) concrete and use in service in dry or wet concrete
- I2 – installation in water-filled drill holes (not sea water) and use in service in dry or wet concrete

Installation:

- Hole drilling by hammer or compressed air drill mode.
- Anchor installation carried out by appropriately qualified personnel and under the supervision of the person responsible for technical matters of the site.

Installation direction:

- D3 - Downward and horizontal and upwards (e.g. overhead) installation.

Friulside Injection System for concrete
KEM HR, KEM HR Blue, KEM HR Tropical, KEM HR Express

Intended use
Specifications

Annex B 1

Table B1: Installation parameters for threaded rod

Anchor size			M 8	M 10	M 12	M 16	M 20	M 24
Diameter of element	$d = d_{nom}$	[mm]	8	10	12	16	20	24
Nominal drill hole diameter	d_0	[mm]	10	12	14	18	24	28
Effective embedment depth	$h_{ef,min}$	[mm]	60	60	70	80	90	96
	$h_{ef,max}$	[mm]	160	200	240	320	400	480
Diameter of clearance hole in the fixture ¹⁾	Prepositioned installation d_f	[mm]	9	12	14	18	22	26
	Push through installation d_f	[mm]	12	14	16	20	24	30
Maximum torque moment	$T_{inst} \leq$	[Nm]	10	20	40	80	120	160
Thickness of fixture	$t_{fix,min} >$	[mm]	0					
	$t_{fix,max} <$	[mm]	1500					
Minimum thickness of member	h_{min}	[mm]	$h_{ef} + 30 \text{ mm}$ $\geq 100 \text{ mm}$			$h_{ef} + 2d_0$		
Minimum spacing	s_{min}	[mm]	40	50	60	80	100	120
Minimum edge distance	c_{min}	[mm]	40	50	60	80	100	120

Table B2: Installation parameters for rebar

Rebar size			Ø 8	Ø 10	Ø 12	Ø 14	Ø 16	Ø 20	Ø 25
Diameter of element	$d = d_{nom}$	[mm]	8	10	12	14	16	20	25
Nominal drill hole diameter	d_0	[mm]	12	14	16	18	20	25	32
Effective embedment depth	$h_{ef,min}$	[mm]	60	60	70	75	80	90	100
	$h_{ef,max}$	[mm]	160	200	240	280	320	400	500
Minimum thickness of member	h_{min}	[mm]	$h_{ef} + 30 \text{ mm}$ $\geq 100 \text{ mm}$			$h_{ef} + 2d_0$			
Minimum spacing	s_{min}	[mm]	50	55	65	70	80	100	130
Minimum edge distance	c_{min}	[mm]	50	55	65	70	80	100	130

Friulsider Injection System for concrete
KEM HR, KEM HR Blue, KEM HR Tropical, KEM HR Express

Intended use
 Installation parameters

Annex B 2

Steel brush RBT

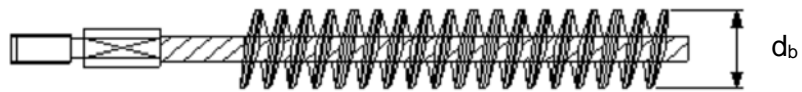

Table B3: Parameter cleaning and setting tools

Threaded Rod	Rebar	d ₀ Drill bit - Ø	d _b Brush - Ø		d _{b,min} min. Brush - Ø
[mm]	[mm]	[mm]	[mm]		[mm]
M8		10	RBT10	12	10,5
M10	8	12	RBT12	14	12,5
M12	10	14	RBT14	16	14,5
	12	16	RBT16	18	16,5
M16	14	18	RBT18	20	18,5
	16	20	RBT20	22	20,5
M20		24	RBT24	26	24,5
	20	25	RBT25	27	25,5
M24		28	RBT28	30	28,5
	25	32	RBT32	34	32,5



Hand pump (volume 750 ml)

Drill bit diameter (d₀): 10 mm to 20 mm
and anchorage depth up to 240 mm



Recommended compressed air tool (min 6 bar)

All applications

Friulside Injection System for concrete
KEM HR, KEM HR Blue, KEM HR Tropical, KEM HR Express

Intended use
Cleaning and setting tools

Annex B 3

Installation instructions

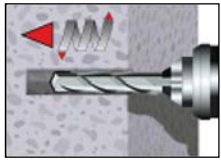

- 1 Drill with hammer drill a hole into the base material to the size and embedment depth required by the selected anchor (Table B1 or B2). In case of aborted drill hole: the drill hole shall be filled with mortar.

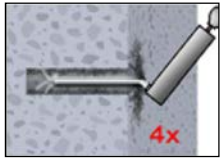

- Attention! Standing water in the bore hole must be removed before cleaning.**
- 2a Starting from the bottom or back of the bore hole, blow the hole clean with compressed air (min. 6 bar) or a hand pump (Annex B 3) a minimum of four times. If the bore hole ground is not reached an extension shall be used.

or

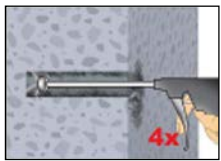

The hand-pump can be used for anchor sizes up to bore hole diameter 20 mm.

For bore holes larger than 20 mm or deeper 240 mm, compressed air (min. 6 bar) **must** be used.

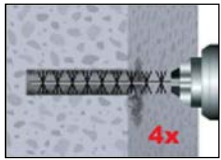

- 2b Check brush diameter (Table B3) and attach the brush to a drilling machine or a battery screwdriver. Brush the hole with an appropriate sized wire brush $> d_{b,min}$ (Table B3) a minimum of four times. If the bore hole ground is not reached with the brush, a brush extension shall be used (Table B3).

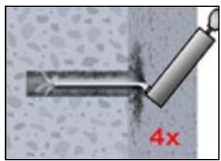

- 2c Finally blow the hole clean again with compressed air (min. 6 bar) or a hand pump (Annex B 3) a minimum of four times. If the bore hole ground is not reached an extension shall be used.

The hand-pump can be used for anchor sizes up to bore hole diameter 20 mm.

For bore holes larger than 20 mm or deeper 240 mm, compressed air (min. 6 bar) **must** be used.

or

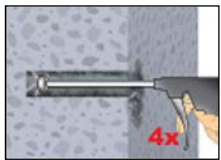

After cleaning, the bore hole has to be protected against re-contamination in an appropriate way, until dispensing the mortar in the bore hole. If necessary, the cleaning repeated has to be directly before dispensing the mortar. In-flowing water must not contaminate the bore hole again

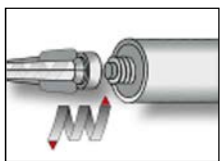

3. Attach a supplied static-mixing nozzle to the cartridge and load the cartridge into the correct dispensing tool. Cut off the foil tube clip before use. For every working interruption longer than the recommended working time (Table B4) as well as for new cartridges, a new static-mixer shall be used.

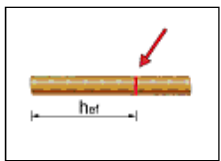

4. Prior to inserting the anchor rod into the filled bore hole, the position of the embedment depth shall be marked on the anchor rods.

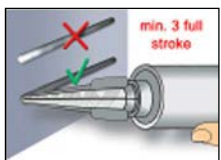

5. Prior to dispensing into the drill hole, squeeze out separately a minimum of three full strokes and discard non-uniformly mixed adhesive components until the mortar shows a consistent grey or blue (KEM HR Blue) colour. For foil tube cartridges it must be discarded a minimum of six full strokes.

Friulside Injection System for concrete
KEM HR, KEM HR Blue, KEM HR Tropical, KEM HR Express

Intended use
 Installation instructions

Annex B 4

Installation instructions (continuation)

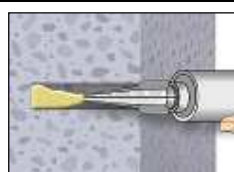

6. Starting from the bottom or back of the cleaned anchor hole fill the hole up to approximately two-thirds with adhesive. Slowly withdraw the static mixing nozzle as the hole fills to avoid creating air pockets. If the bottom or back of the anchor hole is not reached, an appropriate extension nozzle must be used. Observe the gel-/ working times given in Table B4.



7. Push the threaded rod into the anchor hole while turning slightly to ensure positive distribution of the adhesive until the embedment depth is reached.

The anchor should be free of dirt, grease, oil or other foreign material.

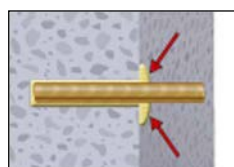

8. Be sure that the anchor is fully seated at the bottom of the hole and that excess mortar is visible at the top of the hole. If these requirements are not maintained, the application has to be renewed. For overhead application the anchor rod should be fixed (e.g. wedges).

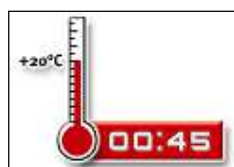

9. Allow the adhesive to cure to the specified time prior to applying any load or torque. Do not move or load the anchor until it is fully cured (attend Table B4).



10. After full curing, the add-on part can be installed with the max. torque (Table B1) by using a calibrated torque wrench.

Table B4: Minimum curing time

Concrete temperature	KEM HR Express		KEM HR, KEM HR Blue ¹⁾		KEM HR Tropical	
	Max. working time	Min. curing time	Max. working time	Min. curing time	Max. working time	Min. curing time
-10 to -6 °C					60 min	4 h
-5 to -1 °C			90 min	6 h	45 min	2 h
0 to +4 °C			45 min	3 h	25 min	80 min
+5 to +9 °C			25 min	2 h	10 min	45 min
+10 to +14 °C	30 min	5 h	20 min	100 min	4 min	25 min
+15 to +19 °C	20 min	210 min	15 min	80 min	3 min	20 min
+20 to +29 °C	15 min	145 min	6 min	45 min	2 min	15 min
+30 to +34 °C	10 min	80 min	4 min	25 min		
+35 to +39 °C	6 min	45 min	2 min	20 min		
+40 to +44 °C	4 min	25 min				
+45 °C	2 min	20 min				
Cartridge temperature	+5°C to +45°C		+5°C to +40°C		0°C to +30°C	

¹⁾ The KEM HR Blue injection mortar has a curing time proof by changing the color from blue to gray after curing minimum time. The curing time proof is only valid for the standard version of the mortar.

Friulside Injection System for concrete
KEM HR, KEM HR Blue, KEM HR Tropical, KEM HR Express

Intended use
 Installation instructions (continuation)
 Curing time

Annex B 5

Table C1: Characteristic values for steel tension resistance and steel shear resistance of threaded rods

Size			M 8	M 10	M 12	M 16	M 20	M 24	
Cross section area	A _s	[mm ²]	36,6	58	84,3	157	245	353	
Characteristic tension resistance, Steel failure ¹⁾									
Steel, Property class 4.6 and 4.8	N _{Rk,s}	[kN]	15 (13)	23 (21)	34	63	98	141	
Steel, Property class 5.6 and 5.8	N _{Rk,s}	[kN]	18 (17)	29 (27)	42	78	122	176	
Steel, Property class 8.8	N _{Rk,s}	[kN]	29 (27)	46 (43)	67	125	196	282	
Stainless steel A2, A4 and HCR, Property class 50	N _{Rk,s}	[kN]	18	29	42	79	123	177	
Stainless steel A2, A4 and HCR, Property class 70	N _{Rk,s}	[kN]	26	41	59	110	171	247	
Stainless steel A4 and HCR, Property class 80	N _{Rk,s}	[kN]	29	46	67	126	196	282	
Characteristic tension resistance, Partial safety factor ²⁾									
Steel, Property class 4.6	γ _{Ms,N}	[-]	2,0						
Steel, Property class 4.8	γ _{Ms,N}	[-]	1,5						
Steel, Property class 5.6	γ _{Ms,N}	[-]	2,0						
Steel, Property class 5.8	γ _{Ms,N}	[-]	1,5						
Steel, Property class 8.8	γ _{Ms,N}	[-]	1,5						
Stainless steel A2, A4 and HCR, Property class 50	γ _{Ms,N}	[-]	2,86						
Stainless steel A2, A4 and HCR, Property class 70	γ _{Ms,N}	[-]	1,87						
Stainless steel A4 and HCR, Property class 80	γ _{Ms,N}	[-]	1,6						
Characteristic shear resistance, Steel failure ¹⁾									
Without lever arm	Steel, Property class 4.6 and 4.8	V ⁰ _{Rk,s}	[kN]	9 (8)	14 (13)	20	38	59	85
	Steel, Property class 5.6 and 5.8	V ⁰ _{Rk,s}	[kN]	11 (10)	17 (16)	25	47	74	106
	Steel, Property class 8.8	V ⁰ _{Rk,s}	[kN]	15 (13)	23 (21)	34	63	98	141
	Stainless steel A2, A4 and HCR, Property class 50	V ⁰ _{Rk,s}	[kN]	9	15	21	39	61	88
	Stainless steel A2, A4 and HCR, Property class 70	V ⁰ _{Rk,s}	[kN]	13	20	30	55	86	124
	Stainless steel A4 and HCR, Property class 80	V ⁰ _{Rk,s}	[kN]	15	23	34	63	98	141
With lever arm	Steel, Property class 4.6 and 4.8	M ⁰ _{Rk,s}	[Nm]	15 (13)	30 (27)	52	133	260	449
	Steel, Property class 5.6 and 5.8	M ⁰ _{Rk,s}	[Nm]	19 (16)	37 (33)	65	166	324	560
	Steel, Property class 8.8	M ⁰ _{Rk,s}	[Nm]	30 (26)	60 (53)	105	266	519	896
	Stainless steel A2, A4 and HCR, Property class 50	M ⁰ _{Rk,s}	[Nm]	19	37	66	167	325	561
	Stainless steel A2, A4 and HCR, Property class 70	M ⁰ _{Rk,s}	[Nm]	26	52	92	232	454	784
	Stainless steel A4 and HCR, Property class 80	M ⁰ _{Rk,s}	[Nm]	30	59	105	266	519	896
Characteristic shear resistance, Partial safety factor ²⁾									
Steel, Property class 4.6	γ _{Ms,V}	[-]	1,67						
Steel, Property class 4.8	γ _{Ms,V}	[-]	1,25						
Steel, Property class 5.6	γ _{Ms,V}	[-]	1,67						
Steel, Property class 5.8	γ _{Ms,V}	[-]	1,25						
Steel, Property class 8.8	γ _{Ms,V}	[-]	1,25						
Stainless steel A2, A4 and HCR, Property class 50	γ _{Ms,V}	[-]	2,38						
Stainless steel A2, A4 and HCR, Property class 50 70	γ _{Ms,V}	[-]	1,56						
Stainless steel A4 and HCR, Property class 80	γ _{Ms,V}	[-]	1,33						
¹⁾ Values are only valid for the given stress area A _s . Values in brackets are valid for undersized threaded rods with smaller stress area A _s for hot dipped threaded rods galvanized according to EN ISO 10684:2004+AC:2009. ²⁾ in absence of national regulation									
Friulsider Injection System for concrete KEM HR, KEM HR Blue, KEM HR Tropical, KEM HR Express								Annex C 1	
Performances Characteristic values for steel tension resistance and steel shear resistance of threaded rods									

Table C2: Characteristic values of tension loads under static and quasi-static action

Anchor size threaded rod				M 8	M 10	M 12	M 16	M 20	M 24
Steel failure									
Characteristic tension resistance		$N_{Rk,s}$	[kN]	$A_s \cdot f_{uk}$ (or see Table C1)					
Partial factor		$\gamma_{Ms,N}$	[-]	see Table C1					
Combined pull-out and concrete cone failure									
Characteristic bond resistance in uncracked concrete C20/25									
Temperature range I: 40°C/24°C	dry and wet concrete	$\tau_{Rk,ucr}$	[N/mm ²]	8,5	8,0	8,0	8,0	8,0	8,0
	flooded bore hole	$\tau_{Rk,ucr}$	[N/mm ²]	8,5	8,0	8,0	8,0	8,0	8,0
Temperature range II: 80°C/50°C	dry and wet concrete	$\tau_{Rk,ucr}$	[N/mm ²]	6,5	6,0	6,0	6,0	6,0	6,0
	flooded bore hole	$\tau_{Rk,ucr}$	[N/mm ²]	6,5	6,0	6,0	6,0	6,0	6,0
Increasing factors for uncracked concrete ψ_c		C25/30		1,04					
		C30/37		1,08					
		C35/45		1,13					
		C40/50		1,15					
		C45/55		1,17					
		C50/60		1,19					
Characteristic bond resistance in cracked concrete C20/25									
Temperature range I: 40°C/24°C	dry and wet concrete	$\tau_{Rk,cr}$	[N/mm ²]	4,5	4,5	4,5	4,5	NPA	
	flooded bore hole	$\tau_{Rk,cr}$	[N/mm ²]	4,5	4,5	4,5	4,5	NPA	
Temperature range II: 80°C/50°C	dry and wet concrete	$\tau_{Rk,cr}$	[N/mm ²]	3,5	3,5	3,5	3,5	NPA	
	flooded bore hole	$\tau_{Rk,cr}$	[N/mm ²]	3,5	3,5	3,5	3,5	NPA	
Increasing factors for cracked concrete ψ_c		C25/30		1,02					
		C30/37		1,04					
		C35/45		1,06					
		C40/50		1,07					
		C45/55		1,08					
		C50/60		1,09					
Concrete cone failure									
Factor for uncracked concrete		$k_{ucr,N}$	[-]	11,0					
Factor for cracked concrete		$k_{cr,N}$	[-]	7,7					
Edge distance		$c_{cr,N}$	[mm]	1,5 h_{ef}					
Axial distance		$s_{cr,N}$	[mm]	2 $c_{cr,N}$					
Splitting failure									
Edge distance	$h/h_{ef} \geq 2,0$	$c_{cr,sp}$	[mm]	1,0 h_{ef}					
	$2,0 > h/h_{ef} > 1,3$			$2 \cdot h_{ef} \left(2,5 - \frac{h}{h_{ef}} \right)$					
	$h/h_{ef} \leq 1,3$			2,4 h_{ef}					
Axial distance		$s_{cr,sp}$	[mm]	2 $c_{cr,sp}$					
Installation factor									
for dry and wet concrete		γ_{inst}	[-]	1,2					
for flooded bore hole		γ_{inst}	[-]	1,2					
Friulsider Injection System for concrete KEM HR, KEM HR Blue, KEM HR Tropical, KEM HR Express									Annex C 2
Performances Characteristic values of tension loads under static and quasi-static action									

Table C3: Characteristic values of shear loads under static and quasi-static action

Anchor size threaded rod		M 8	M 10	M 12	M 16	M 20	M 24	
Steel failure without lever arm								
Characteristic shear resistance Steel, strength class 4.6, 4.8 and 5.6, 5.8	$V_{Rk,s}^0$	[kN]	$0,6 \cdot A_s \cdot f_{uk}$ (or see Table C1)					
Characteristic shear resistance Steel, strength class 8.8 Stainless Steel A2, A4 and HCR, all classes	$V_{Rk,s}^0$	[kN]	$0,5 \cdot A_s \cdot f_{uk}$ (or see Table C1)					
Partial factor	$\gamma_{Ms,V}$	[-]	see Table C1					
Ductility factor	k_7	[-]	1,0					
Steel failure with lever arm								
Characteristic bending moment	$M_{Rk,s}^0$	[Nm]	$1,2 \cdot W_{el} \cdot f_{uk}$ (or see Table C1)					
Partial factor	$\gamma_{Ms,V}$	[-]	see Table C1					
Concrete pry-out failure								
Factor	k_8	[-]	2,0					
Installation factor	γ_{inst}	[-]	1,0					
Concrete edge failure								
Effective length of fastener	l_f	[mm]	$\min(h_{ef}; 12 d_{nom})$					
Outside diameter of fastener	d_{nom}	[mm]	8	10	12	16	20	24
Installation factor	γ_{inst}	[-]	1,0					
Friulsider Injection System for concrete KEM HR, KEM HR Blue, KEM HR Tropical, KEM HR Express							Annex C 3	
Performances Characteristic values of shear loads under static and quasi-static action								

Table C4: Characteristic values of tension loads under static and quasi-static action

Anchor size rebar		Ø 8	Ø 10	Ø 12	Ø 14	Ø 16	Ø 20	Ø 25		
Steel failure										
Characteristic tension resistance	$N_{Rk,s}$	[kN]	$A_s \cdot f_{uk}^{1)}$							
Cross section area	A_s	[mm ²]	50	79	113	154	201	314	491	
Partial factor	$\gamma_{Ms,N}$	[-]	1,4 ²⁾							
Combined pull-out and concrete cone failure										
Characteristic bond resistance in uncracked concrete C20/25										
Temperature range I: 40°C/24°C	dry and wet concrete	$\tau_{Rk,ucr}$	[N/mm ²]	7,0	7,0	7,0	7,0	6,5	6,5	6,5
	flooded bore hole	$\tau_{Rk,ucr}$	[N/mm ²]	7,0	7,0	7,0	7,0	6,5	6,5	6,5
Temperature range II: 80°C/50°C	dry and wet concrete	$\tau_{Rk,ucr}$	[N/mm ²]	5,5	5,5	5,5	5,5	5,5	5,0	5,0
	flooded bore hole	$\tau_{Rk,ucr}$	[N/mm ²]	5,5	5,5	5,5	5,5	5,5	5,0	5,0
Increasing factors for uncracked concrete ψ_c		C25/30		1,02						
		C30/37		1,04						
		C35/45		1,06						
		C40/50		1,07						
		C45/55		1,08						
		C50/60		1,09						
Concrete cone failure										
Factor for uncracked concrete	$k_{ucr,N}$	[-]	11,0							
Edge distance	$c_{cr,N}$	[mm]	1,5 h_{ef}							
Axial distance	$s_{cr,N}$	[mm]	2 $c_{cr,N}$							
Splitting failure										
Edge distance	$h/h_{ef} \geq 2,0$	$c_{cr,sp}$	[mm]	1,0 h_{ef}						
	$2,0 > h/h_{ef} > 1,3$			$2 \cdot h_{ef} \left(2,5 - \frac{h}{h_{ef}} \right)$						
	$h/h_{ef} \leq 1,3$			2,4 h_{ef}						
Axial distance	$s_{cr,sp}$	[mm]	2 $c_{cr,sp}$							
Installation factor										
for dry and wet concrete	γ_{inst}	[-]	1,2							
for flooded bore hole	γ_{inst}	[-]	1,2							
¹⁾ f_{uk} shall be taken from the specifications of reinforcing bars ²⁾ in absence of national regulation										
Friulsider Injection System for concrete KEM HR, KEM HR Blue, KEM HR Tropical, KEM HR Express								Annex C 4		
Performances Characteristic values of tension loads under static and quasi-static action										

Table C5: Characteristic values of shear loads under static and quasi-static action

Anchor size rebar		Ø 8	Ø 10	Ø 12	Ø 14	Ø 16	Ø 20	Ø 25	
Steel failure without lever arm									
Characteristic shear resistance	$V_{Rk,s}^0$	[kN]	$0,5 \cdot A_s \cdot f_{uk}^{1)}$						
Cross section area	A_s	[mm ²]	50	79	113	154	201	314	491
Partial factor	$\gamma_{Ms,V}$	[-]	1,5 ²⁾						
Ductility factor	k_7	[-]	1,0						
Steel failure with lever arm									
Characteristic bending moment	$M_{Rk,s}^0$	[Nm]	$1,2 \cdot W_{el} \cdot f_{uk}^{1)}$						
Elastic section modulus	W_{el}	[mm ³]	50	98	170	269	402	785	1534
Partial factor	$\gamma_{Ms,V}$	[-]	1,5 ²⁾						
Concrete pry-out failure									
Factor	k_8	[-]	2,0						
Installation factor	γ_{inst}	[-]	1,0						
Concrete edge failure									
Effective length of fastener	l_f	[mm]	$\min(h_{ef}; 12 d_{nom})$						$\min(h_{ef}; 300\text{mm})$
Outside diameter of fastener	d_{nom}	[mm]	8	10	12	14	16	20	25
Installation factor	γ_{inst}	[-]	1,0						
¹⁾ f_{uk} shall be taken from the specifications of reinforcing bars ²⁾ in absence of national regulation									
Friulsider Injection System for concrete KEM HR, KEM HR Blue, KEM HR Tropical, KEM HR Express							Annex C 5		
Performances Characteristic values of shear loads under static and quasi-static action									

Table C6: Displacement under tension load¹⁾ (threaded rod)

Anchor size threaded rod		M 8	M 10	M 12	M 16	M 20	M 24	
Uncracked concrete C20/25 under static and quasi-static action								
Temperature range I: 40°C/24°C	δ_{N0} -factor	[mm/(N/mm ²)]	0,03	0,04	0,05	0,07	0,08	0,10
	$\delta_{N\infty}$ -factor	[mm/(N/mm ²)]	0,07	0,08	0,08	0,08	0,08	0,10
Temperature range II: 80°C/50°C	δ_{N0} -factor	[mm/(N/mm ²)]	0,02	0,03	0,03	0,04	0,04	0,05
	$\delta_{N\infty}$ -factor	[mm/(N/mm ²)]	0,15	0,17	0,17	0,17	0,17	0,17
Cracked concrete C20/25 under static and quasi-static action								
Temperature range I: 40°C/24°C	δ_{N0} -factor	[mm/(N/mm ²)]	0,07	0,08	0,07	0,08	NPA	
	$\delta_{N\infty}$ -factor	[mm/(N/mm ²)]	0,13	0,11	0,11	0,10	NPA	
Temperature range II: 80°C/50°C	δ_{N0} -factor	[mm/(N/mm ²)]	0,09	0,08	0,07	0,09	NPA	
	$\delta_{N\infty}$ -factor	[mm/(N/mm ²)]	0,17	0,14	0,14	0,13	NPA	

¹⁾ Calculation of the displacement

$$\delta_{N0} = \delta_{N0}\text{-factor} \cdot \tau; \quad (\tau: \text{action bond stress for tension})$$

$$\delta_{N\infty} = \delta_{N\infty}\text{-factor} \cdot \tau;$$

Table C7: Displacement under shear load²⁾ (threaded rod)

Anchor size threaded rod		M 8	M 10	M 12	M 16	M 20	M 24	
For uncracked concrete C20/25 under static and quasi-static action								
All temperature ranges	δ_{V0} -factor	[mm/kN]	0,02	0,02	0,01	0,01	0,01	0,01
	$\delta_{V\infty}$ -factor	[mm/kN]	0,03	0,02	0,02	0,01	0,01	0,01
For cracked concrete C20/25 under static and quasi-static action								
All temperature ranges	δ_{V0} -factor	[mm/kN]	0,05	0,04	0,03	0,01	NPA	
	$\delta_{V\infty}$ -factor	[mm/kN]	0,07	0,06	0,04	0,02	NPA	

²⁾ Calculation of the displacement

$$\delta_{V0} = \delta_{V0}\text{-factor} \cdot V; \quad (V: \text{action shear load})$$

$$\delta_{V\infty} = \delta_{V\infty}\text{-factor} \cdot V;$$

**Friulsider Injection System for concrete
KEM HR, KEM HR Blue, KEM HR Tropical, KEM HR Express**

Performances
Displacement (threaded rod)

Annex C 6

Table C8: Displacement under tension load¹⁾ (rebar)

Anchor size rebar		Ø 8	Ø 10	Ø 12	Ø 14	Ø 16	Ø 20	Ø 25	
Uncracked concrete C20/25 under static and quasi-static action									
Temperature range I: 40°C/24°C	δ _{N0} -factor	[mm/(N/mm ²)]	0,03	0,06	0,02	0,03	0,05	0,06	0,06
	δ _{N∞} -factor	[mm/(N/mm ²)]	0,08	0,08	0,08	0,08	0,08	0,08	0,08
Temperature range II: 80°C/50°C	δ _{N0} -factor	[mm/(N/mm ²)]	0,03	0,06	0,02	0,03	0,05	0,06	0,06
	δ _{N∞} -factor	[mm/(N/mm ²)]	0,15	0,15	0,15	0,15	0,16	0,16	0,16

¹⁾ Calculation of the displacement

$$\delta_{N0} = \delta_{N0\text{-factor}} \cdot \tau; \quad (\tau: \text{action bond stress for tension})$$

$$\delta_{N\infty} = \delta_{N\infty\text{-factor}} \cdot \tau;$$

Table C9: Displacement under shear load²⁾ (rebar)

Anchor size rebar		Ø 8	Ø 10	Ø 12	Ø 14	Ø 16	Ø 20	Ø 25	
For uncracked concrete C20/25 under static and quasi-static action									
All temperature ranges	δ _{V0} -factor	[mm/kN]	0,04	0,04	0,01	0,01	0,01	0,01	0,01
	δ _{V∞} -factor	[mm/kN]	0,05	0,06	0,02	0,02	0,02	0,02	0,02

²⁾ Calculation of the displacement

$$\delta_{V0} = \delta_{V0\text{-factor}} \cdot V; \quad (V: \text{action shear load})$$

$$\delta_{V\infty} = \delta_{V\infty\text{-factor}} \cdot V;$$

**Friulsider Injection System for concrete
KEM HR, KEM HR Blue, KEM HR Tropical, KEM HR Express**

Performances
Displacement (rebar)

Annex C 7

Table C10: Characteristic values of tension loads under seismic action (performance category C1 + C2)

Anchor size threaded rod			M 8	M 10	M 12	M 16	M 20	M 24
Steel failure								
Characteristic tension resistance (Seismic C1)	$N_{Rk,s,eq,C1}$	[kN]	$1,0 \cdot N_{Rk,s}$				NPA	
Characteristic tension resistance (Seismic C2) Steel, strength class 8.8 Stainless Steel A4 and HCR, Strength class ≥ 70	$N_{Rk,s,eq,C2}$	[kN]	NPA		$1,0 \cdot N_{Rk,s}$		NPA	
Partial factor	$\gamma_{Ms,N}$	[-]	see Table C1					
Combined pull-out and concrete cone failure								
Characteristic bond resistance in cracked and uncracked concrete C20/25								
Temperature range I: 40°C/24°C	dry and wet concrete and flooded bore hole	$\tau_{Rk,eq,C1}$	[N/mm ²]	2,30	2,25	2,30	2,20	NPA
		$\tau_{Rk,eq,C2}$	[N/mm ²]	NPA		0,75	0,95	NPA
Temperature range II: 80°C/50°C		$\tau_{Rk,eq,C1}$	[N/mm ²]	1,85	1,80	1,80	1,75	NPA
		$\tau_{Rk,eq,C2}$	[N/mm ²]	NPA		0,60	0,75	NPA
Increasing factors for cracked concrete ψ_c		C25/30 to C50/60		1,0				
Concrete cone failure								
Factor for uncracked concrete	$k_{ucr,N}$	[-]	11,0					
Factor for cracked concrete	$k_{cr,N}$	[-]	7,7					
Edge distance	$c_{cr,N}$	[mm]	$1,5 h_{ef}$					
Axial distance	$s_{cr,N}$	[mm]	$2 c_{cr,N}$					
Splitting failure								
Edge distance	$h/h_{ef} \geq 2,0$	$c_{cr,sp}$	[mm]	$1,0 h_{ef}$				
	$2,0 > h/h_{ef} > 1,3$			$2 \cdot h_{ef} \left(2,5 - \frac{h}{h_{ef}} \right)$				
	$h/h_{ef} \leq 1,3$			$2,4 h_{ef}$				
Axial distance	$s_{cr,sp}$	[mm]	$2 c_{cr,sp}$					
Installation factor								
for dry and wet concrete	γ_{inst}	[-]	1,2					
for flooded bore hole	γ_{inst}	[-]	1,2					
Friulsider Injection System for concrete KEM HR, KEM HR Blue, KEM HR Tropical, KEM HR Express								Annex C 8
Performances Characteristic values of tension loads under seismic action (performance category C1 + C2)								

**Table C11: Characteristic values of shear loads under seismic action
(performance category C1 + C2)**

Anchor size threaded rod		M 8	M 10	M 12	M 16	M 20	M 24	
Steel failure without lever arm								
Characteristic shear resistance (Seismic C1)	$V_{RK,s,eq,C1}^0$	[kN]	$0,7 \cdot V_{RK,s}^0$				NPA	
Characteristic shear resistance (Seismic C2) Steel, strength class 8.8 Stainless Steel A4 and HCR Strength class ≥ 70	$V_{RK,s,eq,C2}^0$	[kN]	NPA	$0,7 \cdot V_{RK,s}^0$			NPA	
Partial factor	$\gamma_{Ms,V}$	[-]	see Table C1					
Ductility factor	k_7	[-]	1,0					
Steel failure with lever arm								
Characteristic bending moment	$M_{RK,s,eq,C1}^0$	[Nm]	No Performance Assessed (NPA)					
Characteristic bending moment	$M_{RK,s,eq,C2}^0$	[-]	No Performance Assessed (NPA)					
Concrete pry-out failure								
Factor	k_8	[-]	2,0					
Installation factor	γ_{inst}	[-]	1,0					
Concrete edge failure								
Effective length of fastener	l_f	[mm]	$\min(h_{ef}; 12 d_{nom})$					
Outside diameter of fastener	d_{nom}	[mm]	8	10	12	16	20	24
Installation factor	γ_{inst}	[-]	1,0					
Factor for annular gap	α_{gap}	[-]	$0,5 (1,0)^{1)}$					
¹⁾ Value in brackets valid for filled annular gap between anchor and clearance hole in the fixture. Use of special washer Annex A 3 is required.								
Friulsider Injection System for concrete KEM HR, KEM HR Blue, KEM HR Tropical, KEM HR Express							Annex C 9	
Performances Characteristic values of shear loads under seismic action (performance category C1 + C2)								

Table C12: Displacement under tension load¹⁾ (threaded rod)

Anchor size threaded rod			M 8	M 10	M 12	M 16	M 20	M 24
Cracked concrete C20/25 under seismic C1 action								
Temperature range I: 40°C/24°C	δ_{N0} -factor	[mm/(N/mm ²)]	0,07	0,08	0,07	0,08	NPA	
	$\delta_{N\infty}$ -factor	[mm/(N/mm ²)]	0,13	0,11	0,11	0,10	NPA	
Temperature range II: 80°C/50°C	δ_{N0} -factor	[mm/(N/mm ²)]	0,09	0,08	0,07	0,09	NPA	
	$\delta_{N\infty}$ -factor	[mm/(N/mm ²)]	0,17	0,14	0,14	0,13	NPA	

¹⁾ Calculation of the displacement

$$\delta_{N0} = \delta_{N0}\text{-factor} \cdot \tau; \quad (\tau: \text{action bond stress for tension})$$

$$\delta_{N\infty} = \delta_{N\infty}\text{-factor} \cdot \tau;$$

Table C13: Displacement under shear load²⁾ (threaded rod)

Anchor size threaded rod			M 8	M 10	M 12	M 16	M 20	M 24
Cracked concrete C20/25 under seismic C1 action								
All temperature ranges	δ_{V0} -factor	[mm/kN]	0,05	0,04	0,03	0,01	NPA	
	$\delta_{V\infty}$ -factor	[mm/kN]	0,07	0,06	0,04	0,02	NPA	

²⁾ Calculation of the displacement

$$\delta_{V0} = \delta_{V0}\text{-factor} \cdot V; \quad (V: \text{action shear load})$$

$$\delta_{V\infty} = \delta_{V\infty}\text{-factor} \cdot V;$$

Table C14: Displacement under tension load (threaded rod)

Anchor size threaded rod			M 8	M 10	M 12	M 16	M 20	M 24
Cracked concrete C20/25 under seismic C2 action								
All temperature ranges	$\delta_{N,eq(DLS)}$	[mm]	NPA		0,23	0,29	NPA	
	$\delta_{N,eq(ULS)}$	[mm]	NPA		0,43	0,55	NPA	

Table C15: Displacement under shear load (threaded rod)

Anchor size threaded rod			M 8	M 10	M 12	M 16	M 20	M 24
Cracked concrete C20/25 under seismic C2 action								
All temperature ranges	$\delta_{V,eq(DLS)}$	[mm]	NPA		3,6	3,0	NPA	
	$\delta_{V,eq(ULS)}$	[mm]	NPA		7,0	6,6	NPA	

**Friulsider Injection System for concrete
KEM HR, KEM HR Blue, KEM HR Tropical, KEM HR Express**

Performances
Displacements under seismic C1 and C2 action

Annex C 10